

# Complete X-Ray and Gamma-Ray Spectrometer

# X-123CdTe

The X-123CdTe is a complete X-Ray Detector & Gamma-Ray System in one small box that fits in your hand.

## INCLUDES

- 1 CdTe X-Ray & Gamma-Ray Detector and Preamplifier
- 2 Digital Pulse Processor and MCA
- 3 Power Supply and Interface with PC

## Features

- Compact integrated system
- Simple to operate
- Small size (2.7 x 3.9 x 1 in or 7 x 10 x 2.5 cm)
- Low power (2.5 W)
- Light weight (6.3 oz or 180 g)
- USB and RS232 Communication

## Applications

- Medical X-Ray & Gamma-Ray Detection, Mammography, Radiology, Conventional X-Ray
- X-Ray Fluorescence Instrumentation
- Art and Archaeology
- Portable X-Ray & Gamma-Ray Instruments
- X-Ray & Gamma-Ray Research
- Teaching
- Nuclear Plant Monitoring
- Uranium and Plutonium Detection

## Detector

- CdTe for X-Ray & Gamma-Ray detection
- 2-Stage thermoelectrical cooler
- Area: 9 or 25 mm<sup>2</sup>
- Thickness: 1 mm

## Typical Performance

- Resolution at 122 keV < 1.2 keV FWHM
- Optimum energy range: 5 keV to 150 keV
- Max count rate: Up to 2 x 10<sup>5</sup> cps

Detailed performance depends on detector and configuration, which can be optimized for specific applications.

## Overview

The X-123 represents the culmination of 14 years of X-ray detector development at Amptek. Our philosophy has always been to create small, low power, high performance instruments while keeping them simple to operate. The X-123CdTe exemplifies this philosophy by providing in a single package the XR-100T-CdTe X-Ray and Gamma-Ray Detector and its Charge Sensitive Preamplifier; the DP5 Digital Pulse Processor with pulse shaper, MCA, and interface; and the PC5 Power Supply. **All that is needed is a +5 Volts DC input and a USB, Ethernet or RS232 connection to your computer.**

**AMPTEK INC.** 14 DeAngelo Drive, Bedford, MA 01730-2204 U.S.A.

Tel: +1 (781) 275-2242 Fax: +1 (781) 275-3470 e-mail: sales@amptek.com www.amptek.com



## No Liquid Nitrogen

The X-123CdTe is capable of detecting energies from a few keV to several hundreds of keV.

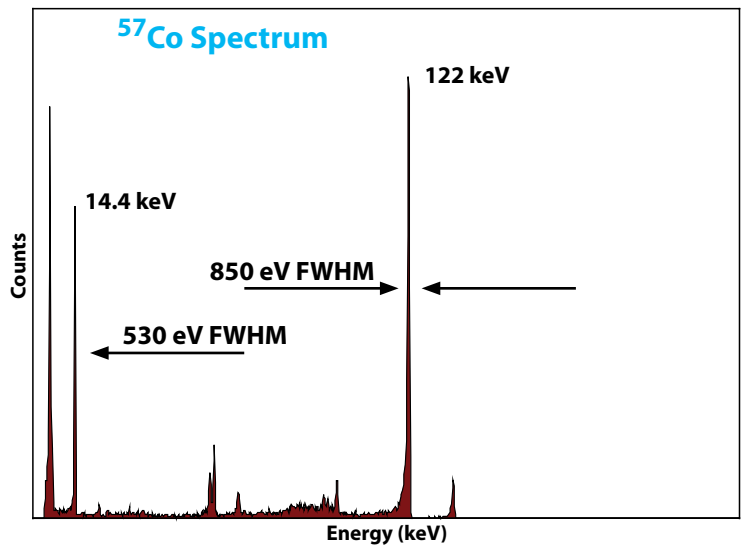

## X-123CdTe Specifications

SYSTEM PERFORMANCE	
<b>Energy Resolution @ 122 keV, <sup>57</sup>Co</b>	9 mm <sup>2</sup> : <1.2 keV FWHM, typical 25 mm <sup>2</sup> : <1.5 keV FWHM, typical
<b>Energy Range</b>	5 to 150 keV. May be used at higher energy with lower efficiency, contact Amptek.
<b>Maximum Count Rate</b> Depends on peaking time. Recommended maxima for 50% dead time with pile-up rejection enabled are shown below:	
<b>DP5 Peaking Time (μs)</b>	2.4 μs      6.4 μs      25.6 μs
<b>Shaping Time (μs)</b>	1.0 μs      2.9 μs      11.6 μs
<b>Recommended Max Rate</b>	1.2 x 10 <sup>5</sup> 4.6 x 10 <sup>4</sup> 1.2 x 10 <sup>4</sup>
DETECTOR AND PREAMPLIFIER	
<b>Detector Type</b>	CdTe (also available with Si-PIN or SDD)
<b>Detector Area</b>	9 mm <sup>2</sup> or 25 mm <sup>2</sup>
<b>Detector Thickness</b>	1 mm
<b>Be Window Thickness</b>	4 mil (100 μm)
<b>Thermoelectric Cooler</b>	2-stage
<b>Preamplifier Type</b>	Amptek custom design with current feedback.
PULSE PROCESSOR	
<b>Gain</b>	Combination of coarse and fine gain yields overall gain continuously adjustable from 0.84 to 127.5
<b>Coarse Gain</b>	Software selectable settings from 1.12 to 102 in 16 log steps. 1.12, 2.49, 3.78, 5.26, 6.56, 8.39, 10.10, 11.31, 14.56, 17.77, 22.42, 30.83, 38.18, 47.47, 66.26, 102.0
<b>Fine Gain</b>	Software selectable, 0.75 to 1.25, 10 bit resolution
<b>Full Scale</b>	1000 mV input pulse @ x1 gain
<b>Gain Stability</b>	<20 ppm / °C (typical)
<b>Pulse Shape</b>	Trapezoidal
<b>Peaking Time</b>	24 software selectable peaking times between 0.8 and 102 μs, approximately log spaced, corresponding to semi-gaussian shaping times of 0.4 to 45 μs.
<b>Dead Time</b>	Total dead time is 1.05 times the peaking time. No conversion time.
<b>Fast Channel Pulse Pair Resolving Time</b>	120 ns
MCA	
<b>Number of Channels</b>	Software selectable to 8k, 4k, 2k, 1k, 0.5k, or 0.25k channels
<b>Presets</b>	Time, total counts, counts in an ROI, counts in a channel
COMMUNICATIONS	
<b>USB</b>	2.0 full-speed (12 Mbps)
<b>Serial</b>	Standard RS232 at 115.2 k or 57.6 Kbaud
<b>Ethernet</b>	10 base-T

POWER																																					
<b>Nominal Input</b>	+5 VDC at 500 mA (2.5 W) (typical). Current depends strongly on detector ΔT. Ranges from 300 to 800 mA at 5 VDC. AC adapter provided.																																				
<b>Input Range</b>	4 V to 6 V (300 to 200 mA, 500 mA max))																																				
<b>High Voltage Supply</b>	Internal multiplier, set to 500 V, adjustable to 750 V																																				
<b>Cooler Supply</b>	Closed loop controller with ΔT <sub>max</sub> = 85°C																																				
GENERAL and ENVIRONMENTAL																																					
<b>Operating Temperature</b>	-20 °C to +50 °C																																				
<b>Warranty Period</b>	1 year																																				
<b>Typical Device Lifetime</b>	5 to 10 years, depending on use																																				
<b>Storage and Shipping</b>	Typical: -20 °C to +50 °C, 10 to 90% humidity non-condensing Long-term storage: 10+ years in dry environment																																				
<b>Compliance</b>	RoHS Compliant																																				
	TUV Certification Certificate #: CU 72101153 01 Tested to: UL 61010-1: 2009 R10.08 CAN/CSA-C22.2 61010-1-04+G1																																				
CONNECTORS																																					
<b>USB</b>	Standard USB Mini 1.1 jack																																				
<b>RS232</b> Standard 2.5 mm stereo audio jack																																					
<table border="1" style="width: 100%;"> <tr> <td style="width: 25%;">Tip</td> <td style="width: 25%;">Transmit</td> <td style="width: 50%;">To PC Receive DB9 pin 2 (DB25 pin 3)</td> </tr> <tr> <td>Ring</td> <td>Receive</td> <td>To PC Transmit DB9 pin 3 (DB25 pin 2)</td> </tr> <tr> <td>Sleeve</td> <td>Ground</td> <td>To PC Ground DB9 pin 5 (DB25 pin 7)</td> </tr> </table>	Tip	Transmit	To PC Receive DB9 pin 2 (DB25 pin 3)	Ring	Receive	To PC Transmit DB9 pin 3 (DB25 pin 2)	Sleeve	Ground	To PC Ground DB9 pin 5 (DB25 pin 7)																												
Tip	Transmit	To PC Receive DB9 pin 2 (DB25 pin 3)																																			
Ring	Receive	To PC Transmit DB9 pin 3 (DB25 pin 2)																																			
Sleeve	Ground	To PC Ground DB9 pin 5 (DB25 pin 7)																																			
<b>Ethernet</b>	Standard Ethernet connector (RJ-45)																																				
<b>Power</b>	Hirose MQ172-3PA(55), Mating plug: MQ172-3SA-CV																																				
<b>Auxiliary</b> 2 x 8 16-pin 2 mm spacing (Samtec part number ASP-135096-01). Mates with cable assembly (Samtec P/N TCMD-08-S-XX.XX-01). Top row odd pins, bottom row even pins. Top right pin = 1, bottom right pin = 2.																																					
<table border="1" style="width: 50%;"> <tr><th>Pin #</th><th>Name</th></tr> <tr><td>1</td><td>SCA1</td></tr> <tr><td>3</td><td>SCA3</td></tr> <tr><td>5</td><td>SCA5</td></tr> <tr><td>7</td><td>SCA7</td></tr> <tr><td>9</td><td>AUX_IN_1</td></tr> <tr><td>11</td><td>AUX_IN_2</td></tr> <tr><td>13</td><td>IO2</td></tr> <tr><td>15</td><td>GND</td></tr> </table>	Pin #	Name	1	SCA1	3	SCA3	5	SCA5	7	SCA7	9	AUX_IN_1	11	AUX_IN_2	13	IO2	15	GND	<table border="1" style="width: 50%;"> <tr><th>Pin #</th><th>Name</th></tr> <tr><td>2</td><td>SCA2</td></tr> <tr><td>4</td><td>SCA4</td></tr> <tr><td>6</td><td>SCA6</td></tr> <tr><td>8</td><td>SCA8</td></tr> <tr><td>10</td><td>AUX_OUT_1</td></tr> <tr><td>12</td><td>AUX_OUT_2</td></tr> <tr><td>14</td><td>IO3</td></tr> <tr><td>16</td><td>GND</td></tr> </table>	Pin #	Name	2	SCA2	4	SCA4	6	SCA6	8	SCA8	10	AUX_OUT_1	12	AUX_OUT_2	14	IO3	16	GND
Pin #	Name																																				
1	SCA1																																				
3	SCA3																																				
5	SCA5																																				
7	SCA7																																				
9	AUX_IN_1																																				
11	AUX_IN_2																																				
13	IO2																																				
15	GND																																				
Pin #	Name																																				
2	SCA2																																				
4	SCA4																																				
6	SCA6																																				
8	SCA8																																				
10	AUX_OUT_1																																				
12	AUX_OUT_2																																				
14	IO3																																				
16	GND																																				

# X-123CdTe Interface Software

## ADMCA

The X-123CdTe can be controlled by the Amptek ADMCA display and acquisition software. This software completely controls and configures the X-123CdTe, and downloads and displays the data. It and supports regions of interest (ROI), calibrations, peak searching, and so on. The ADMCA software includes a seamless interface to the XRF-FP quantitative X-ray analysis software package. Runs under Windows 98SE or later (32-bit only) on PC compatible computers. Windows XP PRO SP2 or later recommended.

## DPP API

The X-123CdTe comes with an Application Programming Interface (API) in the form of a DLL library. The user can use this library to easily write custom code to control the X-123CdTe for custom applications or to interface it to a larger system. Examples are provided in VB, VC++, etc. on how to use the API. A Window CE/Pocket PC version is also provided.

## VB Demonstration Software

The VB demonstration software runs on a personal computer and permits the user to set the X-123CdTe parameters, to start and stop data acquisition, and to save data files. It is provided with source code and can be modified by the user. This software is intended as an example of how to manually control the X-123CdTe through either the USB or RS-232 interface using the most basic calls without the DPP API. This is primarily needed as an example when writing software for non-Windows platforms.

## X-123CdTe Description

Amptek's specialty is X-ray spectrometers, which are small, low power, high performance, and simple to operate. The X-123CdTe combines in a single package Amptek's standard, high performance X-ray spectroscopy components: the XR100T-CdTe detector and preamplifier, DP5 digital pulse processor and MCA, and PC5 power supply. The result is a complete integrated system which can fit in your hand. In many commercially available systems, the preamplifier alone has more size, mass, and power than this integrated system. It requires only 2 connections to run: +5 VDC power and a standard RS-232 or USB bus. With the X-123CdTe, anyone can rapidly obtain high quality X-ray and Gamma-ray spectra.

X-rays & Gamma-rays interact with CdTe atoms to create an average of one electron/hole pair for every 4.43 eV of energy lost in the CdTe. Depending on the energy of the incoming radiation, this energy loss is dominated by either the photoelectric effect or Compton scattering. The probability or efficiency of the detector to "stop" the incoming radiation and create electron/hole pairs increases with the thickness of CdTe.

The detector is mounted on a thermoelectric cooler along with the input FET and coupled to a custom charge sensitive preamplifier. The thermoelectric cooler reduces the electronic noise in the detector and preamplifier, but the cooling is transparent to the user: it operates like a room temperature system.

The pulse processor is the DP5, a digital pulse processor which replaces both the shaping amplifier and multichannel analyzer (MCA) found in most analog systems. The use of digital technology improves several key parameters: (1) better performance, specifically better resolution and operation at higher

count rates; (2) greater flexibility since more configuration options are available and they are selected by software over a RS-232 interface, and (3) improved stability and reproducibility. The DP5 digitizes the preamplifier output, applies real-time digital processing to the signal, detects the peak amplitude (digitally), and bins this value in its histogramming memory, generating an energy spectrum. The spectrum is then transmitted over the DP5's interface to the user's computer. The Amptek DP5 has 6 main function blocks to implement these functions: (1) an analog prefilter; (2) an ADC; (3) a digital pulse shaper; (4) pulse selection logic; (5) histogram logic, and (6) interfacing hardware (which includes a microcontroller) and software.

The power supply is Amptek's PC5, a single board. The input is approximately +5 VDC with a current of about 250 mA. The PC5 uses switching supplies to produce all the low voltages required for the digital processor and the preamplifier. It also includes a high voltage multiplier to produce the detector bias voltage, typically 500 V for 1 mm thick CdTe, but variable up to 750 V, and supply for the thermoelectric cooler which provides closed loop control with a maximum temperature differential of 85 °C.

The complete system is packaged in 7 x 10 x 2.5 cm<sup>3</sup> aluminum box, with the detector mounted on an extender. In its standard configuration, only two connections are required: power (+5 VDC) and serial (either USB or RS232). The DP5 board supports several additional inputs and outputs, if the X-123CdTe will be integrated with other equipment. This includes an MCA gate, a memory buffer select signal, timing outputs, and SCA outputs.

## X-123 Architecture and Connection Diagram

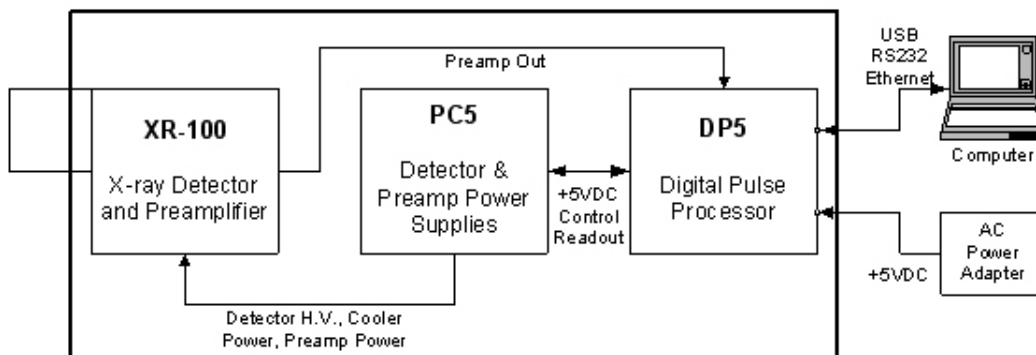

For full system specifications, please see <http://www.amptek.com>

## X-123CdTe Typical Results

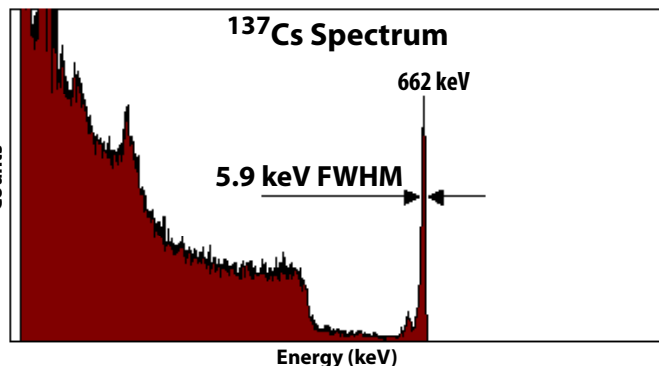
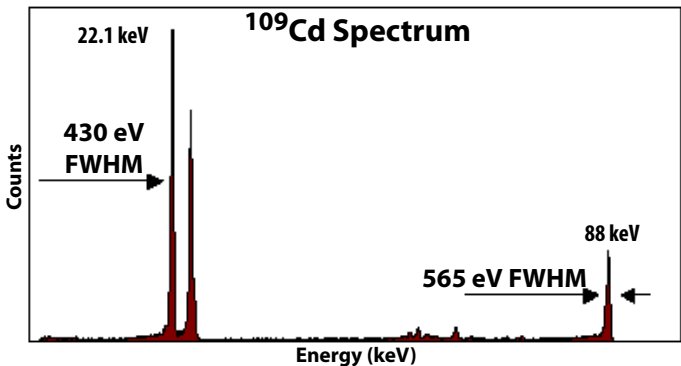
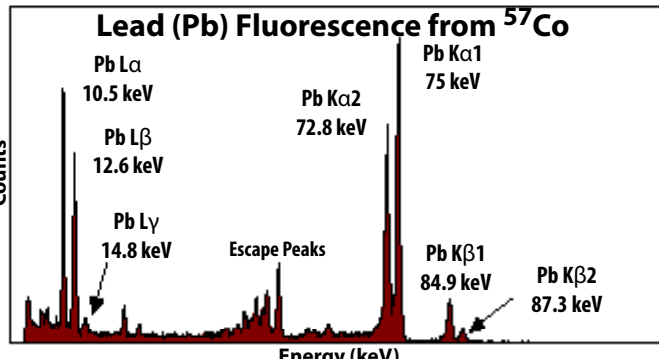
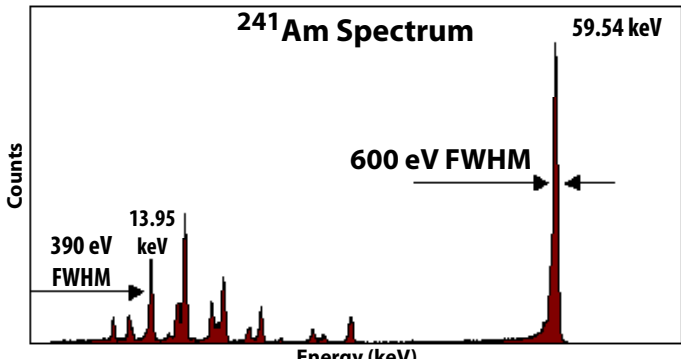

## X-123CdTe Mechanical Dimensions

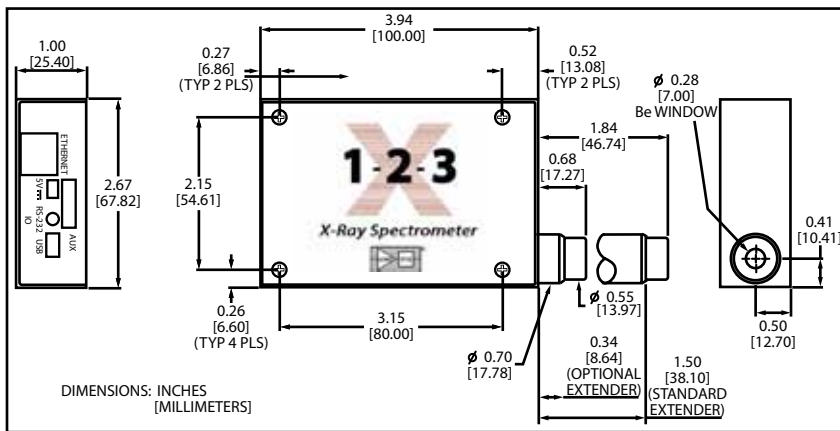

## X-123CdTe Experimental Set-up



The X-123CdTe and Mini-X on the MP1 mounting plate.

## Mounting Kit

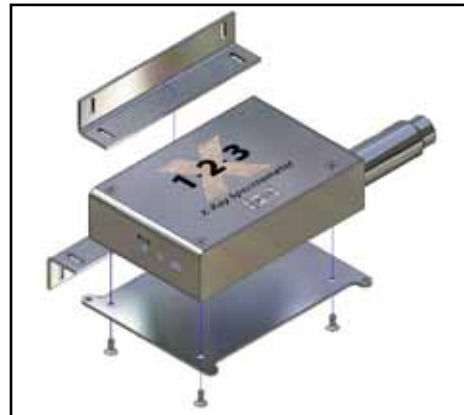

For full system specifications, please see <http://www.amptek.com>

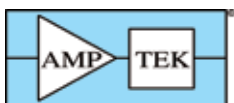

**AMPTEK INC.**

14 DeAngelo Drive, Bedford, MA 01730-2204 U.S.A.

Tel: +1 (781) 275-2242 Fax: +1 (781) 275-3470 e-mail: [sales@amptek.com](mailto:sales@amptek.com) [www.amptek.com](http://www.amptek.com)